

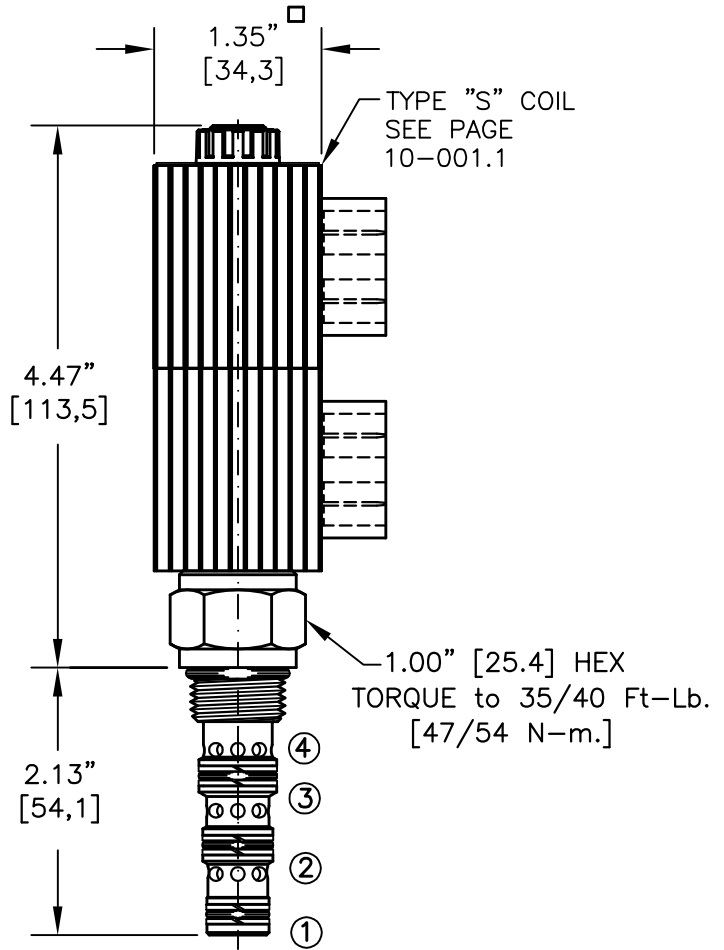

SOLENOID VALVE, 4-WAY, 3-POSITION.
DIRECT ACTING SPOOL

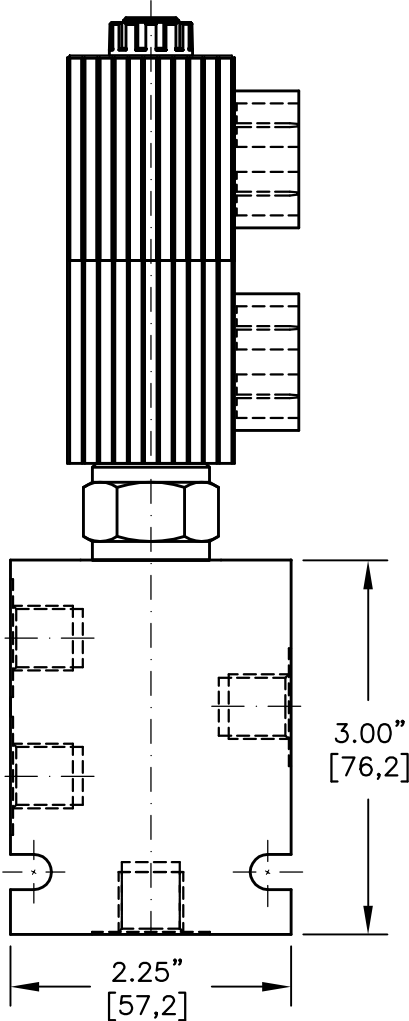
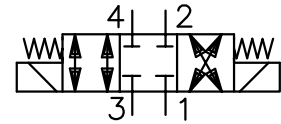

NOTES:

1. FOR ALUMINUM OR STEEL VALVE HOUSING CONFIGURATIONS SEE PAGE 0-041.1
2. SOLENOIDS AVAILABLE WITH DIODES - CONSULT FACTORY.
3. FOR "AC" COILS USE RECTIFIED DIN CONNECTOR 20828.

EMBV-08-X-4L-X-XXX X

BASIC

SIZE
08 = 3/4"-16UNF

SEALS
N = BUNA "N"
V = VITON

TYPE
4L = "L" SPOOL
4-WAY, 3-POSITION

PORTS
0 = CARTRIDGE ONLY
02BX = G 1/4" BSSP
06TX = SAE - #6
"A" = ALUM. HOUSING
"S" = STEEL HOUSING

TERMINALS
L=18GA. 24" LEADS
T=SPADE TERM.
B=BOLT TERM.
G=DIN43650
W=WEATHER-PACK
D=DEUTSCH-DT04-2P
M=METRI-PACK CONN.

VOLTAGE	AMPS
12D = 12 VDC	1.7
24D = 24 VDC	.9
36D = 36 VDC	.6
48D = 48 VDC	.5
115D = 115 VDC	.2

L/M (28,5 cSt)

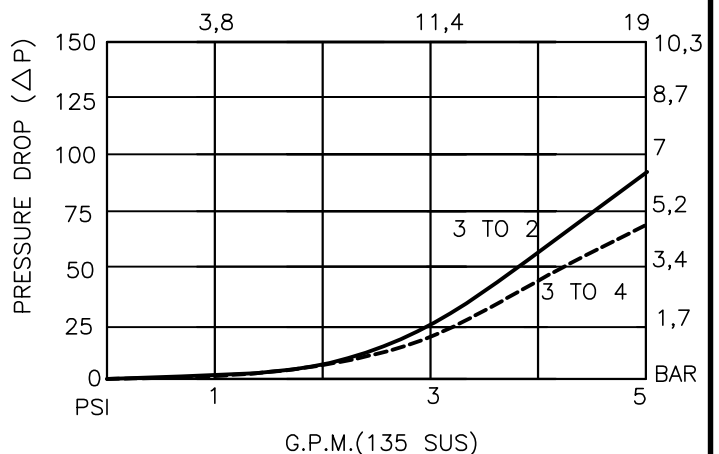

**SOLENOID VALVE 4-WAY, 3-POSITION, SPOOL TYPE****DESCRIPTION**

This unit is a FOUR-WAY, THREE POSITION, cartridge type, spool type, direct acting, screw in type, solenoid operated, double coil, bidirectional closed center selector valve.

OPERATIONS

At the initial position, flow is totally restricted in all ports.

When the upper solenoid coil is energized, the spool in this valve is shifted and allows flow between ports 2 and 1 and ports 3 and 4.

When the lower solenoid coil is energized, the spool in this valve is shifted and allows flow between ports 3 and 2 and ports 4 and 1.

FEATURES AND BENEFITS

Continuous-duty, very low heat rise & waterproof solenoid coil.

Interchangeable solenoid coils & terminations options available.

Hardened precision fitted spool & sleeve provides reliable, long life.

Very efficient, wet-armature solenoid core tube construction.

All external carbon steel parts are plated for longer life against the elements.
All cartridge valves are 100% functionally tested.

Industry common cavity.

SPECIFICATIONS

OPERATING PRESSURE: 5,000 PSI [350 Bar]

PROOF PRESSURE: 10,000 PSI [700 Bar]

FLOW: 5.0 GPM [19 l/m] max. See performance chart.

INTERNAL LEAKAGE: 5cu.in/min [82 cc/m] @ 5,000 PSI [350 Bar]

VALVE HOUSINGS: 2500 PSI [175 Bar] = Aluminum - Anodized.

5000 PSI [350 Bar] = Steel - Unplated.

OPERATING TEMPERATURE: -40° to +250° F. [-40° to +120° C.]

OPERATING MEDIA: All general purpose hydraulic fluids such as
MIL-H-5606, SAE-#10, SAE-#20, etc.

RESPONSE TIME: First indication of change in pressure with 100%
voltage supplied @ 80% of nominal flow rating.

* Pull-in: 50 ms

* Drop-Out: 50 ms

SEAL KIT: SKN-0842 Buna "N"

SKV-0842 Viton

WEIGHT: 1.52 lb [.69 kg] cartridge with coil only.

VALVE CAVITY: #C0840, See Page 0-041.0.